

**Mini-Mite Key Machines**

A lightweight portable machine which you can take with you on the job. Reversible vises for both single and double-sided keys. Gauge fork aligns key blanks accurately. Specially designed carriage accepts all size keys.

**IN-008.....\$832.00**



**Engrave-It™ PRO**

A Professional Engraver for the Lock Shop or Institutional Environment.

- > Sequential numbering
- > Custom lettering for marking keys, popular lock cylinders, and other items
- > Capable of "fine" Engraving for presentation plaques, etc.
- > Variety of fonts and marking styles
- > Various clamping options provided to secure items being engraved
- > Powerful software simplifies common tasks and versatility for advanced projects
- > May be ordered with holders or without
- > Customer supplied PC

**Engrave-It™ PRO ..... \$15,998.00**

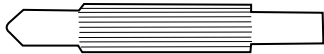

**Deburring Tool**

**IN-879.....\$27.13**

**Automatic/Manual Machine**

Dual function – operates in automatic or manual mode. Cuts large bow and long blade keys. 2-way super jaw. 18 second cutting cycle.

**IN-040.....\$1,866.00**



**Tubular Key Machines**

Specifically designed to cut 1137 tubular keys. Equipped with a spacing guide that automatically locates spacing positions for the standard 7-cut tubular keys and is removable for 8-cut and offset keys.

**IN-009.....\$1,104.00**

**Semi-Automatic Machine**

Wide spacing between vise jaws accommodates new, longer key types. Dial type depth adjustment. 1/4 HP motor. Special vise jaw guard.

**IN-044.....\$1,710.00**



**Automatic/Manual Machine**

Wide spacing between vise jaws accommodates new longer keys. Dial type depth adjustment. 1/4 HP motor. Special vise jaw guard.

**IN-045.....\$1,376.00**





**Bravo III**

A sturdy machine designed to deliver years of service. The Bravo III has 4-way vise jaws, twin carriage shafts, a safety release carriage, and a Micrometer Adjustable Trace Guide. Now equipped with a CU50A cutter for increased duplicating capability. Duplicate most single and double sided key blanks.

**IN-bravoIII.....\$4,410.00**



**Replacement Brushes**

3", 4" & 6" Wire Brushes

**IN-814...3" .....\$22.00**

**IN-815...6" .....\$78.30**

**IN-816...4" .....\$20.56**



**Ford Adapter**

**IN-FOA-1 ..... \$12.30 pair**

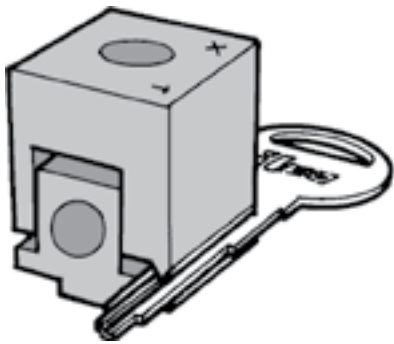

**Super Jaw**

For Ilco 008, 017, 018, 016, 2184CV and 2585DU

**IN-JAW1..... \$116.90 pair**

For Ilco 023, 024, 025, 026; Dominion 132AM; Taylor KD6, KD60& KD70

**IN-JAW2..... \$110.20 pair**



**Schlage Adapters**

**IN-SCA1 (A-Series)..... \$5.30 pair**

**IN-SCA2 (W-Series) .... \$5.30 pair**

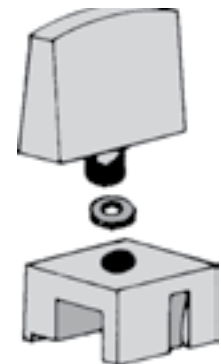

**Thrust Bearings**

**IN-1-59 ..... \$13.80 pair**

**Replacement Belts**

**IN-190-16 (Mini-Mite)..... \$5.38**

**IN-2K-32A (Auto machine)..... \$14.70**



**Milling Cutters**

Cutter	Dia.	Thick	Hole	Key Machines	Price
IN10MC	2.750"	.240"	.875"	DL 125, 126M	<b>\$232.40</b>
IN11MC	2.250"	.290"	.500"	DL 144M, 144MA; Ilco 024; Taylor 144MT-A	<b>\$205.40</b>
IN14MC	2.375"	.375"	.375"	Ilco 2178U, 2178UA, 2178UC, 178U; HPC 1200CM	<b>\$190.90</b>
IN19MC	2.875"	.281"	.500"	Ilco 2183D, 2183HM, 010-006; Keil 1, 11/2, 10	<b>\$123.40</b>
IN34MC	2.250"	.250"	.500"	Ilco 2585DI, J2584CV, 2184DC; Keil 41/2, 121/2, 131/2, 15; Cole 1000, 3000, 5000	<b>\$95.30</b>
IN8UC	2.375"	.242"	.375"	Ilco 2178U, 2178UA, 2178UC, 178U	<b>\$190.90</b>
INCU1	2.250"	.250"	.500"	Taylor KD1, KD1A, KD5, KD6, KD6AG, KD8, KD9	<b>\$64.40</b>
INCU5	2.250"	.250"	.500"	Taylor KD1, KD5, KD20, KD6; Curtis A   various models	<b>\$90.30</b>
INP19MC	2.875"	.281"	.500"	Ilco 2183DM, 2183HM, 010-006; Keil 1, 11/2, 10	<b>\$163.30</b>
INP9MC	2.875"	.206"	.500"	Ilco 016, 017, 108	<b>\$192.30</b>
INX23MC	2.375"	.093"	.500"	DL 143M, 145M; Taylor 145MT-A	<b>\$119.00</b>
INP23MC	2.375"	.093"	.500"	ILCO 045	<b>\$154.90</b>

**End Milling Cutters**

Cutter	Dia.	Thick	Hole	Key Machines	Price
IN16C	.187"			Ilco 009; Taylor KD90, KD30	<b>\$85.10</b>
IN17MC	.063"			Ilco 2182B; Keil 7½	<b>\$169.00</b>

**Side Milling Cutters**

Cutter	Dia.	Thick	Hole	Key Machines	Price
IN30SMS	2.375"	.030"	.500"	Ilco H2585SMS, 2184CD, 2584DV; HPC 9110; Keil 12S, 121/2S, 15S, 151/2S	<b>\$90.40</b>

**Slotter Cutters**

Cutter	Dia.	Thick	Hole	Key Machines	Price
IN10FS	2.500"	.030"	.375"	Ilco 2177-ID, 2179-IM, 2175-IA	<b>\$95.20</b>
IN13FSHS	2.250"	.045"	.437"	Segal 815-1815; HPC 6210, 6200, 9310 DKM; Taylor KD10	<b>\$85.00</b>
IN15FSHS	2.500"	.045"	.375"	Ilco 2177-ID, 2179-IM, 2175-IA	<b>\$76.70</b>
IN17	2.063"	.274"	.500"	Ilco 2196IK; Keil 61/2	<b>\$169.00</b>
IN25-1	2.500"	.030"	.500"	Keil 101/2	<b>\$107.10</b>
IN27	2.250"	.045"	.500"	Ilco 2184CD, H2584CV; DL 146, 145M; HPC 9100, 9110; Taylor KD1; Keil 41/2, 121/2	<b>\$62.40</b>
IN27-1	2.250"	.030"	.500"	Ilco 2184CD, H2584CV; DL 145M, 146M; HPC 9100, 9110; Taylor KD1; Keil 41/2, 121/2	<b>\$61.10</b>
IN27-2	2.375"	.030"	.500"	Ilco 2585DU; Keil 151/2	<b>\$60.40</b>
IN32	2.063"	.030"	.500"	Ilco 2196K; Keil 61/2	<b>\$103.40</b>
IN3FSHS	2.250"	.250"	.500"	Taylor KD1, KD1A, KD5, KD6, KD6AG, KD8, KD9	<b>\$57.70</b>
IN7FS	2.500"	.040"	.375"	Ilco 2177-ID, 2179-IM, 2175-IA, 178	<b>\$163.30</b>

**Fine Milling Cutters**

Cutter	Dia.	Thick	Hole	Key Machines	Price
IN23RF	2.250"	.250"	.500"	Ilco 2184CD, H2184CV, 2585KDU, 008, 190; DL 9100, 9110; Taylor KD1, KD5, KD20; Keil 41/2, 121/2, 131/2, Curtis 2000	<b>\$64.60</b>
IN9RF	2.750"	.250"	.375"	Ilco 2179-IM	<b>\$101.90</b>
INR9RF	2.750"	.250"	.375"	Ilco 2179-IM	<b>\$101.90</b>

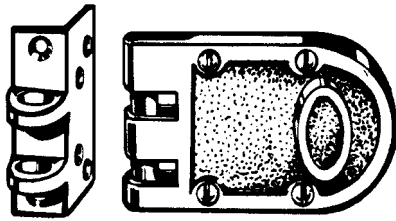

**Single Cylinder Jimmy Proof**

Bronze lacquered finish. Operates by key outside or turn knob inside. 10 per case.

**IN-530CP(CARDED) ..... \$19.13**

**IN-530..... \$17.20**

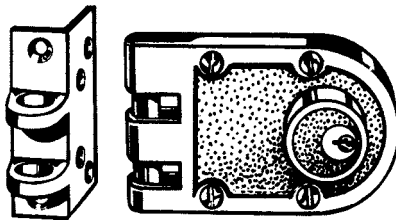

**Double Cylinder Jimmy Proof**

Bronze lacquered finish. Operates by key from both sides. 10 per case.

**IN-535CP(CARDED) ..... \$22.87**

**IN-535..... \$21.00**

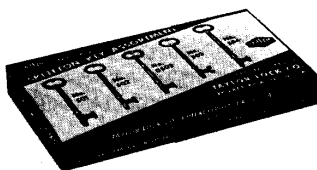

**Skeleton Key Assortment**

35 total keys – 5 different

**IN-2SKA.....\$142.40**

**Die Cast Rim Cylinders**

CP=Clear Pack  
(Specify KA or KD)

**IN-605KW .....\$5.73**

**IN-605KWCP ..\$6.13**

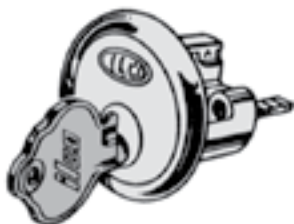

**Rim Latch Deadlock**

Replaces most Night Latches with no additional drilling or mortising. Operates by key outside and turn knob inside. 10 per case.

**IN-545CP(carded) ..... \$14.53**

**IN-545.....\$12.00**

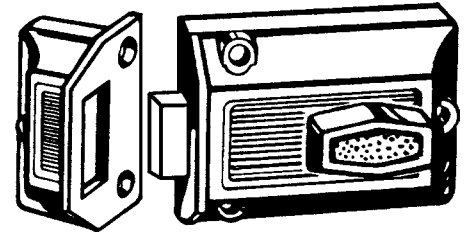

**Night Latches**

Economical Night Latch operates by key outside and turn knob inside. Bolt may be held back by turn knob. 10 per case.

**IN-220CP(carded) .....\$14.53**

**IN-220.....\$12.00**

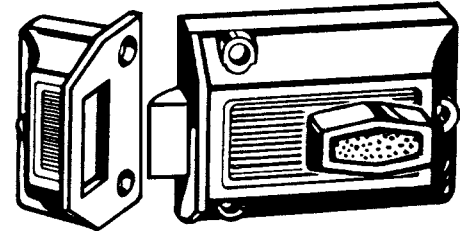

**Vertical Bit Key Rim Lock**

**IN-590.....\$24.87**

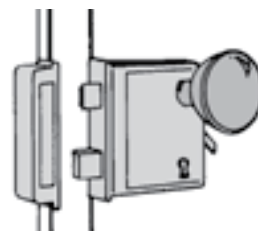

**Horizontal Bit Key Rim Lock**

**IN-591.....\$24.87**

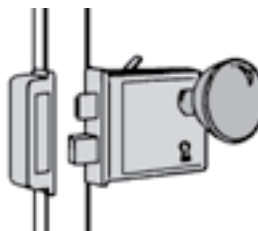

**Bit Mortise Locksets**

A universal replacement lock. Includes two knobs, threaded spindle, lock body and two trim plates. 5 per case.

**IN-215.....\$24.87**

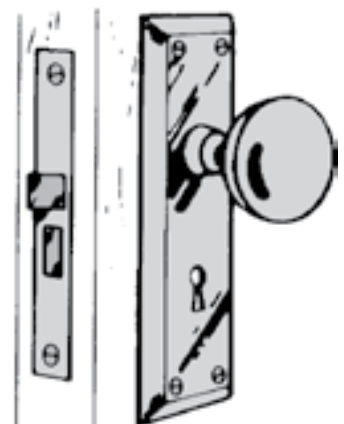

**4500 Series  
Cylindrical Deadbolts**

Accepts any standard 1" or 1-1/8" mortise cylinder with an AR cam (cylinders not included).

10 per case.

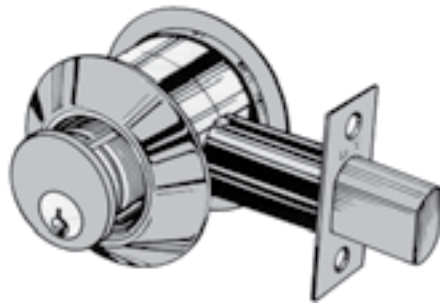

Model	Description	Price
IN-4514-03	Single cylinder – 2-3/4" backset/brass	<b>\$67.78</b>
IN-4513-25	Single cylinder – 2-3/8" backset/chrome	<b>\$55.32</b>
IN-4523-03	Double cylinder – 2-3/8" backset/brass	<b>\$62.52</b>
IN-4514-25	Single cylinder – 2-3/4" backset/chrome	<b>\$55.32</b>
IN-4523-03	Double cylinder – 2-3/8" backset/brass	<b>\$62.52</b>
IN-4523-25	Double cylinder – 2-3/8" backset/chrome	<b>\$54.90</b>
IN-4524-03	Double cylinder – 2-3/4" backset/brass	<b>\$65.32</b>
IN-4524-25	Double cylinder – 2-3/4" backset/chrome	<b>\$54.90</b>

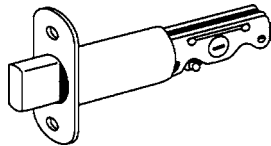

**Replacement Bolts  
Standard Face**

IN-4500-03-5000	2-3/8"	<b>\$16.73</b>
IN-4510-03-5001	2-3/4"	<b>\$16.73</b>

**Drive-In Bolt**

IN-4540-03-5014	2-3/8"	<b>\$20.87</b>
IN-4550-03-5001	2-3/4"	<b>\$20.87</b>

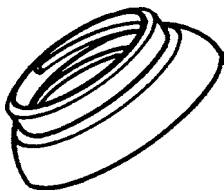

**Adjustable Cylinder Collars**  
5/16" 13/32"

**IN-861A-03-10 .....\$6.66**

**IN-861A-26D-10.....\$6.66**



**Window Locks**

Die case, 5-disc tumbler cylinder.

Specify KA or KD.

**IN-203.....\$10.13**

**Mortise Cash Box Nut**

**IN-869.....\$3.78**



**Flat Tumblers**

**IN-1600-04-11 .....\$8.47**



**1/2" Bolt Flat Tumblers**

**IN-1625-04-11 .....\$9.33**



**Couch Flat Tumblers**

**IN-1650-04-11 .....\$9.33**



**Long Ear Flat Tumblers**

**IN-1675-04-11 .....\$21.60**

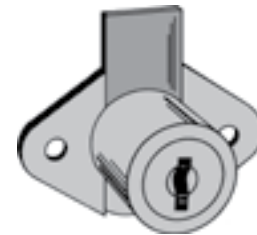

**Desk & Drawer Lock**

7/8" diameter hole. Bolt extends 3/8".

Specify KA or KD.

No.	Diameter	Price
IN-1702-04-41	7/8"	<b>\$10.60</b>
IN-1703-04-41	1-1/8"	<b>\$10.60</b>

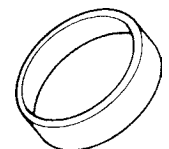

**Cylinder Spacing Rings**

IN-861D-03-10	5/32"	<b>\$2.16</b>
IN-861D-26D-10	5/32"	<b>\$2.16</b>
IN-861D-46-10	5/32"	<b>\$2.16</b>
IN-861F-03-10	1/4"	<b>\$2.16</b>
IN-861F-26D-10	1/4"	<b>\$2.16</b>
IN-861F-46-10	1/4"	<b>\$2.16</b>
IN-861Q-03-10	3/8"	<b>\$2.58</b>
IN-861Q-26D-10	3/8"	<b>\$2.58</b>
IN-861Q-46-10	3/8"	<b>\$2.58</b>



**How To Order Solid Brass Rim and Mortise Cylinders**

**Sample Order: IN7015 – 03 – AA**

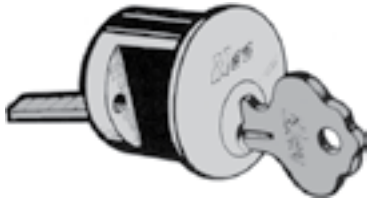

**Rim Cylinders..... \$17.10**

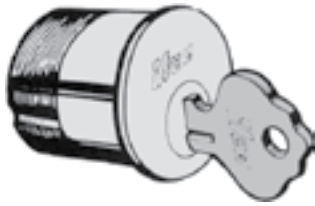

**Mortise Cylinders..... \$16.35**

Type	Finish	Standard Keyways
<b>7015</b> Rim	<b>03</b> Polished brass	<b>AA</b> Arrow
<b>7165</b> 1" mortise KA2	<b>25</b> Satin chrome	<b>SX</b> Schlage C-K
<b>7185</b> 1-1/8" mortise KA2	<b>46</b> Duranodic	<b>KS</b> Kwikset
<b>7205</b> 1-1/4" mortise KD		<b>GA</b> Sargent LA
		<b>RB</b> Russwin D1
		<b>SC</b> Schlage C
		<b>YA</b> Yale 8
		<b>CA</b> Corbin 60

**Non-Standard Keyways (10 cyl. minimum order)**

<b>NA</b> Composite R1064E	<b>UE</b> Lori 80
<b>NB</b> Composite HR1	<b>LA</b> Lockwood 1004
<b>CB</b> Corbin 67 1001EN	<b>RA</b> Russwin 5981R
<b>CC</b> Corbin 77 R1001EN	<b>GB</b> Sargent LA-LC
<b>CD</b> Corbin 59A1-A2	<b>GC</b> Sargent RA-RC
<b>L4</b> Corbin/Russwin	<b>CE</b> SE Schlage E
<b>XE</b> Dexter 67 D1054K	<b>SF</b> Schlage F
<b>DA</b> Dominion S54F	<b>FA</b> Segal 9
<b>DB</b> Dominion D05/D06	<b>WA</b> Weiser E, Falcon E
<b>UA</b> Ilco X1054K	<b>YG</b> Yale GA
<b>UB</b> Lori L100 Eagle11929	<b>RC</b> Russwin 981-852
<b>UD</b> Lori 90	

**Mortise Cylinder Cams ..... \$14.40 10/pk**

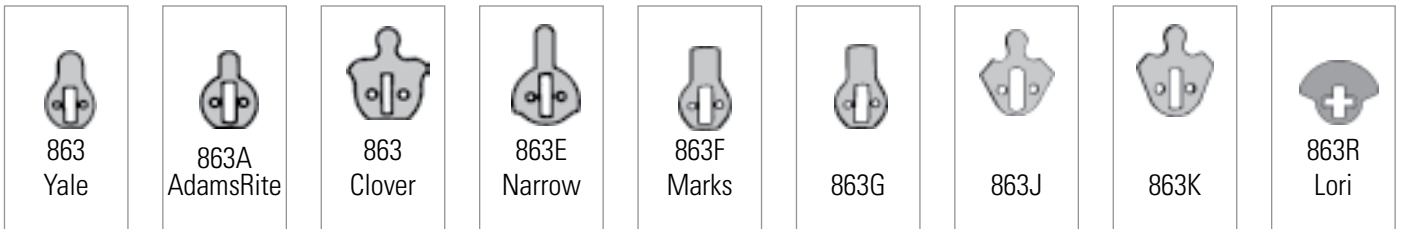

**IN-15995 Universal Combination Cylinder**

Operates most grade 1 & 2 locksets and leversets plus Arrow D, E, F, D; Schlage B100, B200, B400; H Series Deadlocks. Solid Brass Plug & Housing. 6 tailpieces included

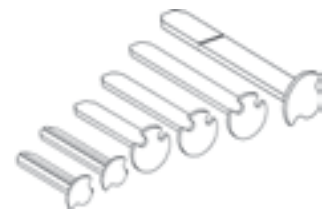

Part #	Keyway	Price
IN-15995-AA	Arrow 1170	<b>\$19.65</b>
IN-15995-CD	Corbin 59A1-A2	<b>\$22.95</b>
IN-15995-CA	Corbin 60	<b>\$19.65</b>
IN-15995-RB	Russwin D1	<b>\$19.65</b>
IN-15995-GA	Sargent LA	<b>\$19.65</b>
IN-15995-GB	Sargent LA-LC	<b>\$19.65</b>
IN-15995-SX	Schlage C-L	<b>\$19.65</b>
IN-15995-SE	Schlage E	<b>\$19.65</b>
IN-15995-SC	Schalge C	<b>\$15.15</b>
IN-15995-FA	Segal 9	<b>\$19.65</b>
IN-15995-YA	Yale 8	<b>\$15.15</b>

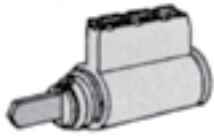

**Sample Order: IN15395AA-26D**

**Lockset Replacement Cylinders**

10 cylinder minimum order for non-standard cylinders

**Standard \$17.85 ea. .... Other \$20.78 ea.**

**Standard Keyways**

<b>AA</b>	Arrow
<b>SX</b>	Schlage C-K
<b>KS</b>	Kwikset
<b>GA</b>	Sargent LA
<b>RB</b>	Ruswin D1
<b>SC</b>	Schlage C
<b>YA</b>	Yale 8
<b>CA</b>	Corbin 60

**Non-Standard Keyways**

<b>NA</b>	Composite R1064E
<b>NB</b>	Composite HR1
<b>CB</b>	Corbin 67 1001EN
<b>CC</b>	Corbin 77 R1001EN
<b>CD</b>	Corbin 59A1-A2
<b>CE</b>	Corbin/Ruswin L4
<b>XE</b>	Dexter 67 D1054K
<b>DA</b>	Dominion S54F
<b>DB</b>	Dominion D05/D06
<b>UA</b>	Ilco X1054K
<b>UB</b>	Lori L100 Eagle11929
<b>UD</b>	Lori 90
<b>UE</b>	Lori 80
<b>LA</b>	Lockwood 1004
<b>RA</b>	Ruswin 5981R
<b>GB</b>	Sargent LA-LC
<b>GC</b>	Sargent RA-RC
<b>SE</b>	Schlage E
<b>SF</b>	Schlage F
<b>FA</b>	Segal 9
<b>WA</b>	Weiser E, Falcon E
<b>YG</b>	Yale GA

**Dummy & Thumbturn Cylinders**

1" - supplied with AR cam  
1-1/8" & 1-1/4" with Yale cam



**Dummy Cylinders ..... \$9.90**

1" Supplied with AR cam  
1-1/8" & 1-1/4" with Yale cam



**Turn-Knob..... \$16.13**

Item #	Size	Finish
<b>Dummy</b>		
IN-7160DC-25	1"	Brush Chrome
IN-7160DC-3	1"	Brass
IN-7160DC-46	1"	Duranodic
IN-7180DC-25	1-1/8"	Brush Chrome
IN-7180DC-3	1-1/8"	Brass
IN-7180DC-46	1-1/8"	Duranodic
IN-7200DC-25	1-1/4"	Brush Chrome
IN-7200DC-3	1-1/4"	Brass
IN-7200DC-46	1-1/4"	Duranodic
<b>Turn-Knob</b>		
IN-7161TK-25	1"	Brush Chrome
IN-7161TK-3	1"	Brass
IN-7161TK-46	1"	Duranodic
IN-7181TK-25	1-1/8"	Brush Chrome
IN-7181TK-3	1-1/8"	Brass
IN-7181TK-46	1-1/8"	Duranodic
IN-7201TK-25	1-1/4"	Brush Chrome
IN-7201TK-3	1-1/4"	Brass
IN-7201TK-46	1-1/4"	Duranodic
<b>Dummy Rim Cylinders</b>		
IN-7010	<b>\$16.60</b>	US3 or 26D

**1539 Series Exploded View**

